

Chapel Hill Newsletter



March 2016

a note from the pastor

As we enter this Lent season, we are learning about open doors and the opportunities they present themselves from God. God places open doors before us (Rev. 3:7-8) as opportunities to serve Him, but also to learn about ourselves and our gifts. Open doors can be frightening because they represent change and uncertainty of not knowing what is on the other side.

Researchers have shown people have two different mind-sets about life. One is a closed mind-set, that is, they believe "that life is a fixed amount of gifts and talents, and their worth depends on how talented they are." Second is the open mind-set "that what matters is not raw ability; what matters is growth." With the open mind-set people, the goal is to grow beyond where they are today and failure is something to be learned from. Closed-door thinking would like David's brothers telling him that Goliath can't be fought and the rich young ruler thinking discipleship would be nice, but it is overpriced.

To be an open-door person would mean to embrace an open mind-set along with a set of disciplines and practices that will help us to regularly walk through open doors. Open doors always seem scarier than closed doors. Closed doors may look safe, but they leave God on the other side of the door. With open doors, we have big choices to make. We ask questions like: what is on the other side, what will it require of me, or what will it cost me? But we never know until we walk through.

In Genesis 12, God asked Abram to get up and go (an open door) to a place He would show to Abram. I am sure Abram asked where is it, how long will it take, and what will it be like there? But all God said was go and Abram went. Sometimes we just have to take a step through the door in-faith, trusting God with the unknown. Faith grows when God says to "go" and we say yes.

God's doors are not always obvious. Going through an open door means I will have to be able to trust God with my future when the path I'm called to take does not look like the obvious one. God set an open door before Abram, one that would lead to a new identity, a new faith, and a new purpose. We too are invited to enter open doors leading to a new identity, a new faith, and a new faith. But know this, if we are willing to enter the open door for God, He will bless us. Abram went based on that blessing God promised Abram causing him to live out of an attitude of abundance rather than an attitude of scarcity. This is God's mission – to bless us out of His great abundance.

So what do we say when God invites us to go (open door)? John Ortberg once wrote a response to this question saying "if I go, I might mess up, but if I don't go, if I don't risk, if I don't try, if I don't say yes, I will never do something wonderful for God."

As you journey through this Lent season ask yourself this question – What will it take for me to trust God and to say yes by entering the open door God places before me? I believe that God is doing something magnificent in this world today and I encourage all of us (even myself) to find the courage to cultivate a willingness to say yes to God's open doors. God still calls. God still sends. And if you say yes ... Oh, the places you will go!

Join us on Sunday morning as learn about the open doors God places before us.

Peace to you,

Pastor Mark

**SERMONS AND SCRIPTURE READINGS
FOR MARCH**

- March 6 Numbers 11:5-15 "Entering a door"
 March 13 Romans 12:3 "Open doors and you"
 March 20 John 16:16-23 "Closed doors"
 March 27 John 10:7, 9-10; Revelation 4:1 "The door in the tomb"

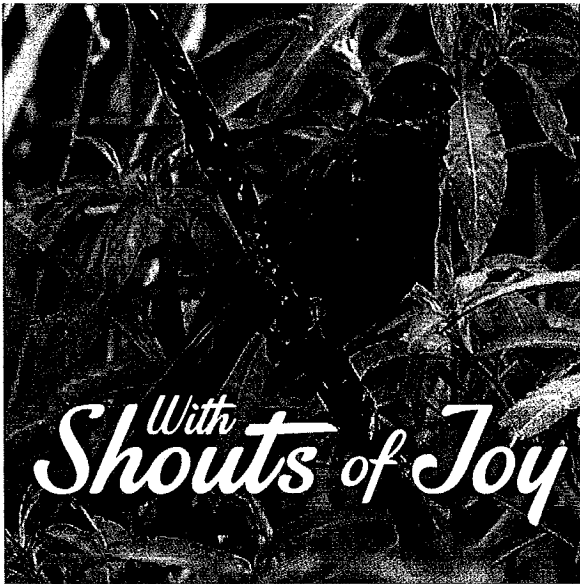

**We Are
BLESSED**

Keep in our Prayers

Our Pastor
and
Those individuals who are serving
within our church fellowship and
our community.
May their lives show Christ in all they
do and say.

Holy Week Schedule at Chapel Hill UMC

- March 25 7 pm Good Friday Service
 March 27 8 am Sunrise Service
 Following Sunrise – breakfast
 10:30 am Easter Worship

Lenten Evening Services Schedule: All services at 7:00pm

- March 6 @ Berrien Springs UMC with Forrester Brothers Concert
 March 13 @ Hinchman UMC with Rev Mark Mitchell -preaching
 March 20 @ Arden UMC Rev. Linda Gordon - preaching
 March 24 @ Scottdale UMC with Communion
 March 25 @ Sodus Chapel Hill with Good Friday service

CHRISTIAN JOURNEYS

FROM SKYLIGHT PATHS®
PUBLISHING

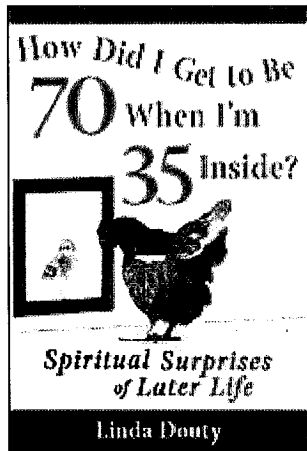

By Linda Douty

Quality Paperback Book
\$16.99

Discusses the challenges and surprises of aging by talking about how you *actually* feel, not what you're *supposed* to feel. Warm and down-to-earth; offers a spiritually grounded method to adjust to the unexpected and live each day with more purpose and joy.

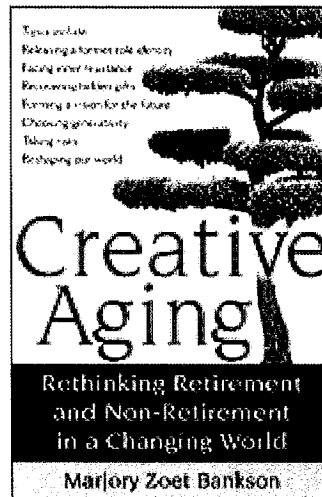

By Marjorie Zoet Bankson

Quality Paperback Book
\$16.99

Explores the spiritual dimensions of retirement and aging and offers creative ways for you to share your gifts and experience, particularly when retirement leaves you questioning who you are when you are no longer defined by your career.

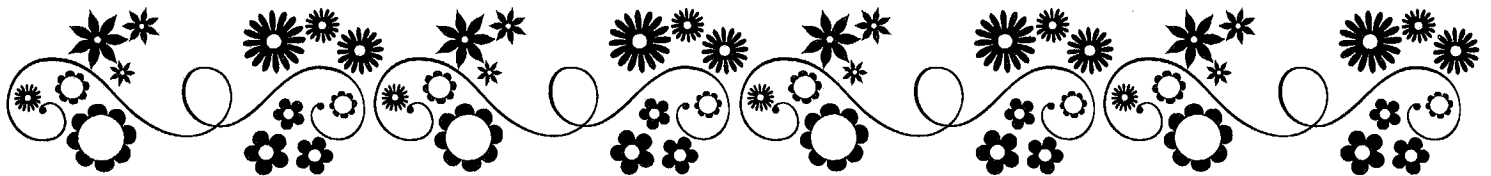

Not By Race, But By God's Grace By M.S. Lowndes

We've been joined as family together Through God's unmerited grace a union
beyond nationality, beyond culture, creed and race.
United together through Jesus Christ, no matter where we come from, for the
grace of God has no limit, nor boundaries we can't go beyond.
But it extends right across the world to every corner of the globe the light of
God must reach out toward the ones that do not know.
That they will believe in Jesus Christ and be filled with God's own light, for
Jesus accepts all that would come, no one will He ever deny.
For we were once in darkness too, dying and lost in our sin, but in God's
love, He saved our souls and placed His love within.
We've come from different walks of life and so many different lands but it
shouldn't matter in the family of God and we must come to understand.
That when our Lord looks upon us, He does not see our race, but looks straight
into our open hearts where He's filled us with His grace.
For this is what truly binds us together in His love, brothers and sisters in the
Lord, washed clean by Jesus blood.
For when we come together in love, we are truly unified it shouldn't matter
where we've come from, for Jesus will be gloried!

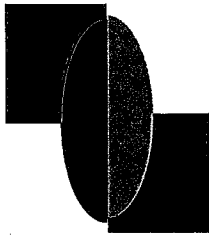

REMEMBER TO LOOK ON CHAPEL HILL'S INFORMATION BULLETIN BOARD EACH SUNDAY

The Kalamazoo District Weekly Newsletter is posted every Friday
and
MI Connect News is posted every Friday

The office must first receive the email before it can be posted - Thanks

Opportunities to Support other Community Churches

Below are 3 opportunities to support ministries in Southwest Michigan:

Coloma United Methodist Church will be serving an Irish Stew Dinner on Saturday, March 12th as part of the Chamber of Commerce's overall festivities.

The dinner will be from 5-7pm in the fellowship hall of CUMC.

There will be **no charge** for the dinner, donations will be accepted.

There will be a silent auction during the dinner.

All proceeds are going to fund Missionary Robert Amundsen at Thousandsticks UMC, in the Red Bird Missionary Conference in Kentucky.

On St. Patrick's Day, March 17, the Berrien County Association of Churches will offer a Corned Beef and Cabbage Dinner at Stevensville United Methodist Church, 5506 Ridge Rd.

The dinner will be from 4:30 pm to 6:30 pm.

The cost is \$12.00 per person, drink and dessert included.

The proceeds will benefit the Benton Harbor Street Ministry.

Following the dinner, Stevensville UMC will sponsor a concert by folk singers Anne Hills and David Roth.

The concert will start at 7:30 pm.

A donation of \$15.00 is suggested.

The proceeds will benefit Lighthouse Ministries of Benton Harbor.

ArtsBridge presents a **Collage Concert and Exhibit** on **Sunday, March 6, 4 p.m.** at **First Presbyterian Church**, 475 Green Avenue on Morton Hill in Benton Harbor. Performers include

I'm Saving Myself Academy Choir directed by Bonita Mitchell and music students from the Citadel Dance & Music Center directed by Susan Dietrich-Reed. There will also be an exhibit of Mark Kelly's photographs celebrating the coastal lifestyle. A reception will follow the program. For more information, call (269) 925-7075, visit the website FirstPresBH.org.



one - eighty

Turnaround Church Conference

Thursday, March 10, 2016

8:30am - 4:30pm

General Sessions presented by Dr. Rod Kalajainen

(Pastor of Redeemer Church)

Dr. Winston Worrell

(Director, World Methodist Evangelism Institute, Atlanta, GA)

Workshops for 2016 Include: Getting Your Ministry Aligned, Proverbs for Leadership, Evangelism, Leading a Contemporary Worship Team, Planning Big Days, Welcoming Guests, How Do You Spell Volunteers, and Strategic Planning, Interactive Hospitality

Conference Cost - includes lunch

\$49/per person until Feb. 26 , \$59 after Feb. 26 * Group rates available

IT' SPRING FLING TIME - CALLING ALL WOMEN OF CHAPEL HILL



On Saturday March 12th, the Kalamazoo District of United Methodist Women is sponsoring a Spring Fling Tea at Portage Chapel Hill UMC. It will be held from 1:00 to 3:00 pm. We will Hear the History of Tea, Sample Tea & Tea Foods, and listen to the Children's Bell Choir of Portage Chapel Hill. The tea is open to all women and girls 5 and up. Registration is \$7.00 for adults and \$5.00 for girls. The registration is due March 5th. I will like to get a car load together and go, If you are interested please see Joyce Mitchell

Thank you note from Laura Neal's Family

Our family would like to thank all of our friends at Chapel Hill who came to moms visitation and funeral. It was wonderful to see so many of you. A big thank you to the ladies for providing an absolutely wonderful luncheon and a thank you to Linda Calahan for playing the organ so beautifully. Thanks to the minister and secretary for their help as well. Pastor George Fleming was brilliant as always and he brought mom back to life for us when she was so vital in the life of the church. Mom would have loved the celebration of her long life! We were blessed to have had her for close to 89 years. Dementia robbed her of many memories but she never lost the love for her family and friends and continued to have her wonderful smile. Thank you from the bottom of our hearts.

"Perhaps they are not stars in the sky, but rather openings where our loved ones shine down to let us know they are happy"

Patti Miller and Tim Neal



Ministry Needs

Lay Participant Forms

Please sign up for lay participant positions.

Liturgists: Greeters:

Coffee Hour: Nursery:

The sign up sheets are on the foyer table.

Contacts:

Liturgists: Linda Bennett 944-1961

Greeters: Karen Hook 463-8535

Coffee Hour: Sandy Keath 208-0115

Nursery:

THE LAWN MOWING SCHEDULE IS
OUT ON THE TABLE IN THE FOYER.



FLOWER ORDERS DUE TO THE OFFICE BY
SUNDAY, MARCH 6, 2016

The deadline for weekly announcements going into the **bulletin** is Thursday at 10:00 a.m. However, we take prayer requests until the bulletin is printed.

The deadline for **newsletter** items for **April** is **Thursday March 24 at 9:00 am**



MARCH BIRTHDAYS

- 03/01 Joan Hires
Emily Curtis
- 03/05 Joshua Scott
Cody Dorman
- 03/07 Bob McKenzie
Marilyn Mort
Steve Peters
Brandon Theobald
Ethan Weldert
- 03/08 Adam Hudson
- 03/09 Nathane Corwin
Clif Nelson
- 03/11 Maya Curtis
Anita Harner
Maude Moore
- 03/12 Sandy Keath
Dale Quattrin
- 03/14 Daniel Turbyfill
- 03/16 Frank Paulin
- 03/18 Suzanne Dorman
- 03/20 Shireen Hall
Kayla Kettlehut
- 03/21 Hannah Grootendorst
Bob Kraklau
Dennis Kraklau
Kristin Trail
- 03/22 Callie Oviatt
- 03/23 George Herder
- 03/24 Phyllis Hall
- 03/25 Carston Harner
Frank Nehring
- 03/28 Lexi Martin
- 03/30 Riley Brink



MARCH

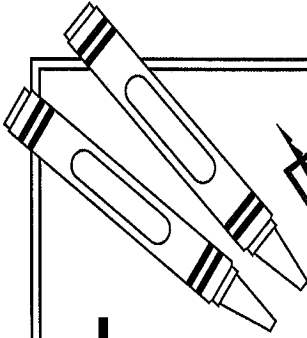

- 03/01 Charles and Cindy Cantrell
- 03/16 Joe and Diane Lambrecht
- 03/23 Denny and Mickey Bennett
- 03/26 Jim and Patsy Robertson
- 03/29 Robert and Janet Hahn

If we have missed a birthday or anniversary, or have you listed incorrectly, please call the office so that we may update our information.



PUZZLE

Lamb of God

 John the Baptist knew Jesus was the Messiah — and offered a special greeting when he saw Jesus. 

Directions: Cut apart the squares and arrange them in a rectangle in numerical order, starting with #1 in the top left and going across to #7. Continue building four more rows of seven squares each, to reveal John 1:29, NIV.

| | | | | | |
|----------|----------------|---------|---------------|----|------------|
| 1 | 2 "...Look, | 25 | 4 Lamb | 30 | 16 sin |
| 8 | 33 | 27 | 12 the | 23 | 18 the |
| 29 | 6 God, | 32 | 20 takes | 10 | 34 |
| 24 | 17 of | 5 of | 19 world!" | 22 | 11 away |
| 3 the | 31 | 26 | 9 who | 13 | 15 |
| 14 | 7 | 28 | 35 | 21 | |

LITTLE LAMBS

Make these cute treats as a reminder that Jesus our Savior is also the Lamb of God.

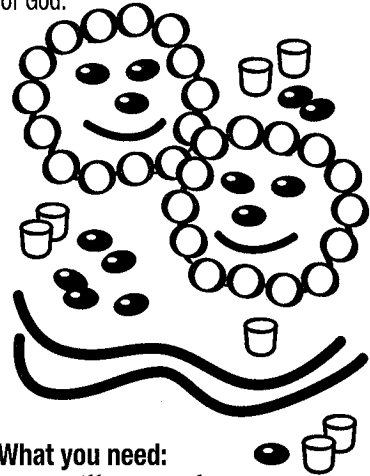

What you need:

- Vanilla cupcakes
- Vanilla frosting
- Butter knife
- Mini marshmallows
- Jellybeans
- Red licorice

What you do:

1. Bake and frost the cupcakes.
2. Place marshmallows around the edge of each cupcake.
3. Cut green or blue jellybeans in half and place two on each cupcake as eyes. Cut pink jellybeans in half and place one below each pair of eyes as a nose.
4. Cut thin strips of licorice, and place one on each cupcake as a mouth.
5. Enjoy!

March

| Sun | Mon | Tue | Wed | Thu | Fri | Sat |
|--|---|---|---|---|---|---|
| | | 1 Prayer group 10:00 am | 2 Bells 6:30pm | 3 | 4 | 5 |
| 6 Communion | 7 Finance Meeting 7:00pm | 8 Prayer group 10:00 am | 9 Bells 6:30pm | 10 ¹⁸⁰ Conference 8:30am to 4:30pm | 11 | 12 10:30 am Baby Shower |
| 13 Children Participate in Worship Service | 14 Trustee's Meeting 7:00pm | 15 Prayer group 10:00 am SPRC Meeting 7:00pm | 16 Bells 6:30pm | 17 | 18 | 19 |
| 20 Palm Sunday | 21 | 22 Prayer group 10:00 am Church Council Meeting 7pm | 23 Bells 6:30pm | 24 Newsletter Info Due | 25 Good Friday Service at 7:00pm | 26 |
| 27 Easter Sunday No Potluck | 28 | 29 Prayer group 10:00 am | 30 Bells 6:30pm Newsletter Goes Out | 31 | | |



A Reflection of Christ's Love
Chapel Hill United Methodist Church
4071 Naomi Rd
Sodus, MI 49126-9768

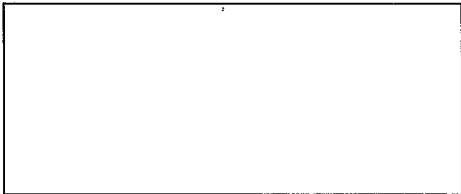

CHAPEL HILL NEWS

March 2016

Phone: (269) 927-3454

Parsonage: (269) 925-4528

E-mail: chumcsodus@comcast.net

Websites: www.chumcsodus.org

www.chapelhill-craftshow.org

Adult Sunday School: 9:30 a.m.

Sunday Worship: 10:30 a.m.

K-12 Sunday School: after the
children's message

Mark Mitchell, Pastor

Church Office Hours
Tuesday through Friday
9:00 a.m. - 1:00 p.m.

In case of emergency when the office is closed,
please try the parsonage (925-4528).

Wondering if We Will Have Worship?

Since Michigan has been known to occasionally have inclement weather, should our worship service and Sunday school need to be cancelled for safety reasons, our policy is to contact TV channels 16 and 22 by 8:00 a.m. Sunday morning.

If in doubt about services being held please check both of these sources for their closing lists. Let's all stay safe this winter !